

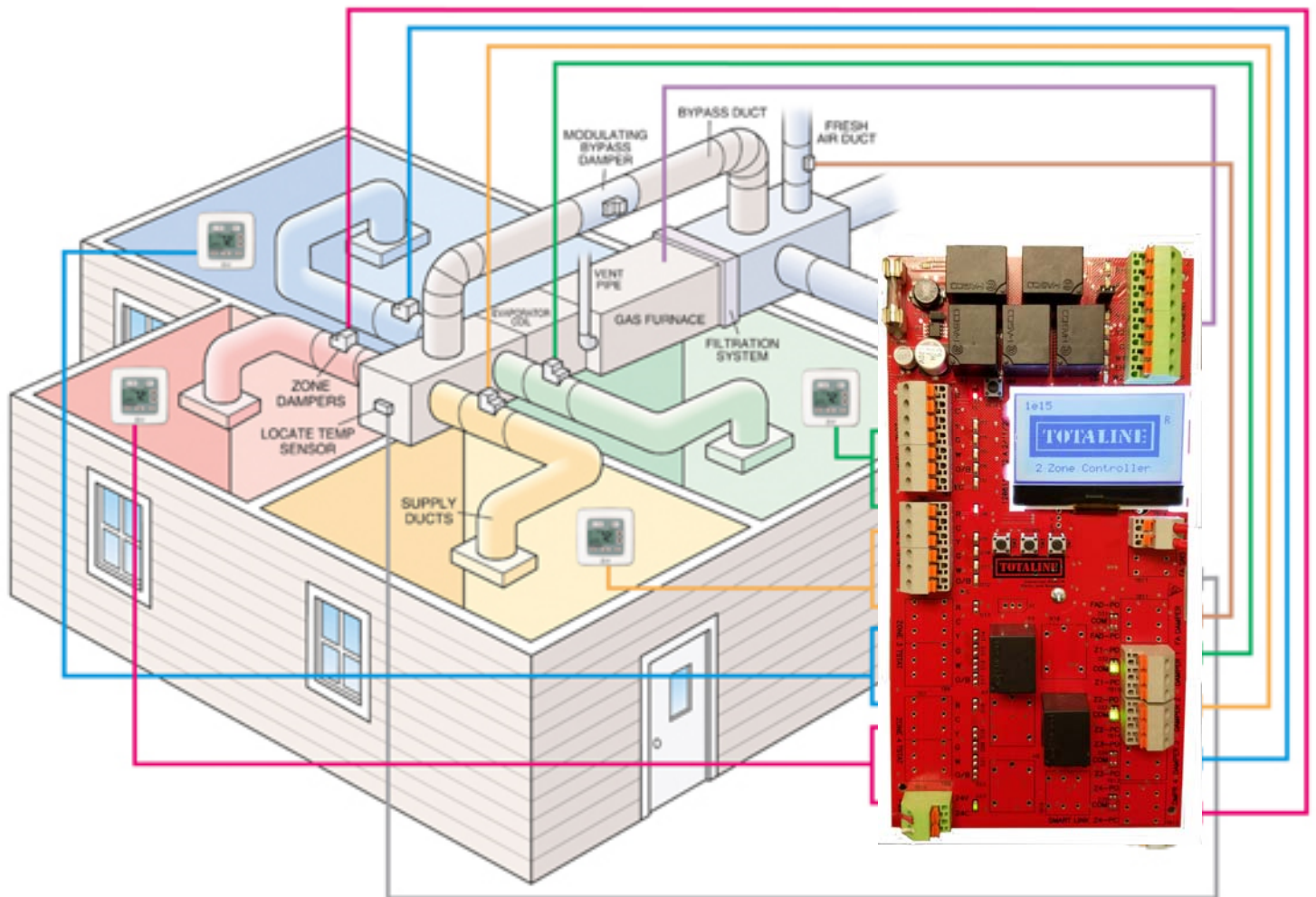

**Universal HVAC/R
Parts and Supplies**

TL-EZ2N 2-ZONE CONTROLLER



READ THIS INSTALL GUIDE COMPLETELY BEFORE INSTALLING CONTROLLER

Zone Controller Installation and Start-up Guide v17

Input Ratings:

Voltage: 18-40 VAC 50/60 HZ transformer of 40 VA or more

Current Draw:

Zone Controller: 10 VA

PO/PC Dampers: 3 VA

PC/SR Dampers: 8VA

PO/SR Dampers: 8 VA

All VA specifications at 24 VAC

Temperature Ratings:

Shipping: -20° to 150° F

Operating: -20° to 165° F

Humidity Ratings:

5% to 95% RH non-condensing

Wiring:

18-guage SOLID wire

Fuse:

5 x 20mm 30 ma Slo-Blo

CONFIGURATION OPTIONS

NOTE: ONLY OPTIONS AVAILABLE ON THE TL-EZ2N CONTROLLER ARE LISTED

Option #03	Set system type
Option #04	Set temperature display (Fahrenheit or Celsius)
Option #05	Set system stage (two-stage systems ONLY)
Option #06	Set thermostat type (heat pump systems ONLY)
Option #07	Set reversing valve actuation (heat pump systems ONLY)
Option #09	Set gas high temp cutout (gas and electric furnace ONLY)
Option #10	Set low temp cutout
Option #11	Set heat pump high temp cutout (heat pump systems ONLY)
Option #12	Set aux. heat cut-in temp (single-stage heat pump ONLY)
Option #13	Set aux. heat cut-in time (single-stage heat pump ONLY)
Option #21	Set second stage lockout - on or off (two-stage systems ONLY)
Option #22	Set zone 1 priority
Option #23	Set auto changeover time - 10 or 15 minutes
Option #25	Allow zone 1 thermostat staging (two-stage systems ONLY)
Option #26	Set 2nd stage cooling cut-in time based on time only
Option #27	Set 2nd stage cooling cut-in time based on time and temp
Option #28	Set 2nd stage cooling cut-in time (time only)

MOUNTING

Mount the controller near the HVAC equipment. It can be mounted on a wall, stud, roof tress or the supply ductwork. It can be mounted in any orientation, including flat on top of the supply plenum. When mounting in a vertical position it should be leveled for a good appearance.

1. Remove the clear lid from the enclosure.
2. Place the controller in the desired position and use the base as a template to mark the hole locations.
3. Attach the controller to the surface with the appropriate screws (not included). If attaching the controller to drywall or ductboard, use hollow wall anchors to secure in place.

POWER

The Totaline System **REQUIRES A SEPARATE 24 VAC TRANSFORMER** (not included) for powering the TL-EZ2N controller, zone thermostats and dampers. It is recommended to install a fuse on the 24 VAC output from the transformer.

DO NOT ATTEMPT TO POWER THE CONTROLLER FROM THE TRANSFORMER IN THE INDOOR UNIT!

TRANSFORMER SIZING

The 24 volt transformer must be sized and fused based on the controller, the total dampers and the thermostats.

Totaline Device	Power
TL-EZ2N Controller	8 VA
Power Open/Power Close Damper	3 VA
Spring Return Damper	18VA
Typical Thermostat	2 VA

EXAMPLE: Transformer Calculation:

1 TL-EZ2N (10 VA)
 + 2 POC Dampers (3 VA X 2)
 + 2 Thermostats (2 VA X 4)
 = 20 VA Total

FUSE SIZING RULE OF THUMB

Transformer VA	Fuse Size
40	2 amp
75	3 amp
100	4 amp



CAUTION: Voltage Hazard. Can cause electrical shock or equipment damage. Disconnect power before beginning installation. Wire entire zone panel before applying transformer power.

Connect the transformer to the 24V and 24C inputs on the zone control board.

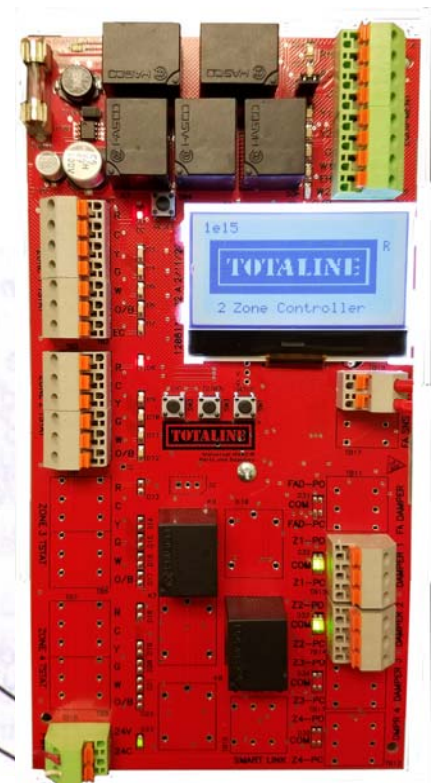
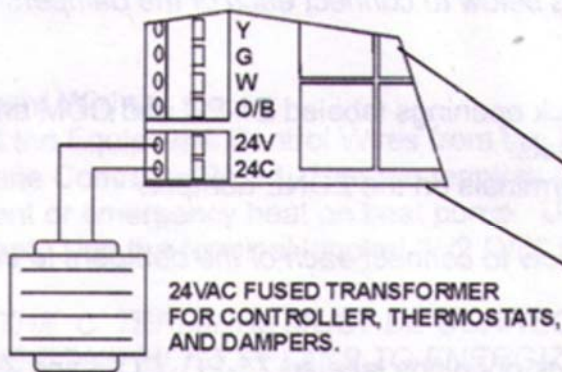

Wiring

Install thermostats using instructions provided with thermostats.

The Totaline controller is compatible with most thermostats that have a common connection or are battery operated. The TL-EZ2N will use time and supply air temperature, or time only to automatically manage staging. This eliminates the need for multi-stage thermostats.

On **HEAT PUMP** equipment ONLY, either Gas/Electric or Heat Pump thermostats can be used. It is recommended to use a Heat Pump thermostat with an Emergency Heat switch on Zone 1 for all heat pump installations. An emergency heat call can ONLY be initiated from the ZONE 1 THERMOSTAT.

1. Connect either single stage gas/electric or heat pump thermostats to each terminal block labeled *Zone 1 TSTAT* and *Zone 2 TSTAT*.
2. The Zone 1 TSTAT will operate Damper 1. The Zone 2 TSTAT will operate Damper 2.
3. Using 18 Gauge Solid Thermostat Wire, strip 1/2 inch of insulation from each wire. Hold down the orange button and push the thermostat wire into the SCREWLESS terminals on the control board.
4. Connect the other end of the thermostat wire to the corresponding terminals on the thermostat.
5. To use the **EC** terminal on the Zone 1 TSTAT, a separate switch must be used to supply 24 VAC to this terminal. You may also use a 2-stage thermostat on Zone 1 ONLY if you want to control Zone 1 staging by connecting Y2 from the thermostat to the **EC** terminal on the Zone 1 terminal block.

HEAT PUMP THERMOSTAT

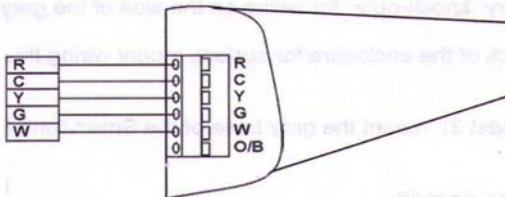
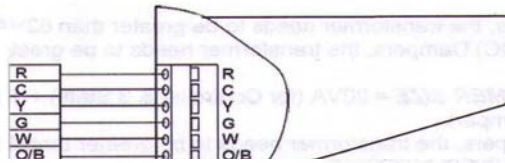

GAS/ELECTRIC THERMOSTAT

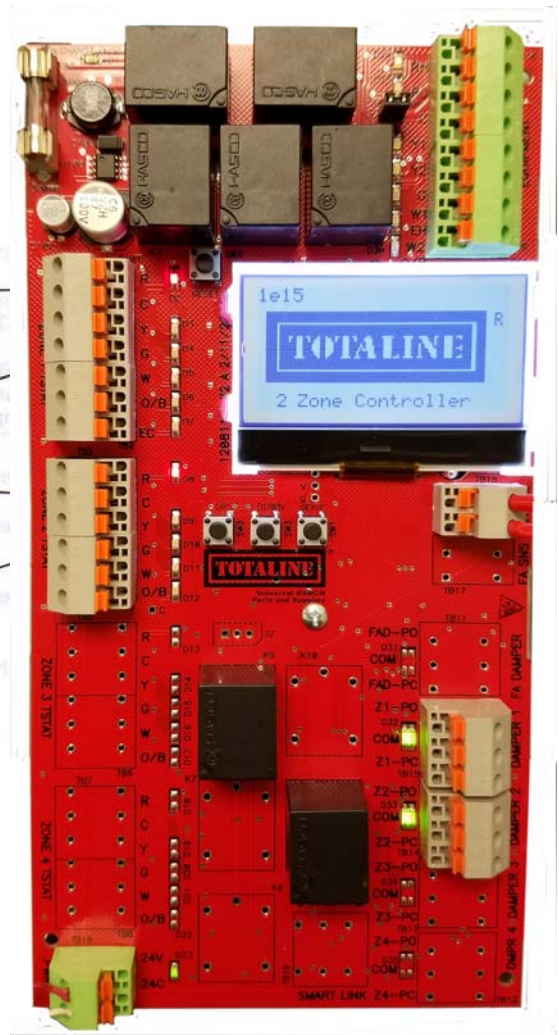

Wiring

The Totaline controller will operate either 2-Wire Power Close/Spring Open dampers, or 3-Wire Power Open/Power Close dampers.

Power Close/Spring Open 2-Wire Dampers

1. Use 18/2 or 18/3 solid core wire.
2. Strip 1/2 inch of insulation from each wire.
3. Hold down the orange button on the Damper 1 terminal block labeled **Z1-PC** and **COM** and push the two wires for the zone damper into the SCREWLESS terminals.
4. Connect the other end of the wires to the SCREWLESS terminals on the zone damper.
5. Repeat steps 3 and 4 for the Zone 2 damper.

Power Open/Power Close 3-Wire Dampers

1. Use 18/3 solid core wire
2. Strip 1/2 inch of insulation from each wire.
3. Hold down the orange button on the Damper 1 terminal block and push the three wires for the zone damper into the SCREWLESS terminals. Use *WHITE* for Common (C), *GREEN* for Power Open (PO) and *RED* for Power Close (PC).
4. Connect the other end of the wires to the terminals on the zone damper, using the same color code.
5. Repeat steps 3 and 4 for the Zone 2 damper.

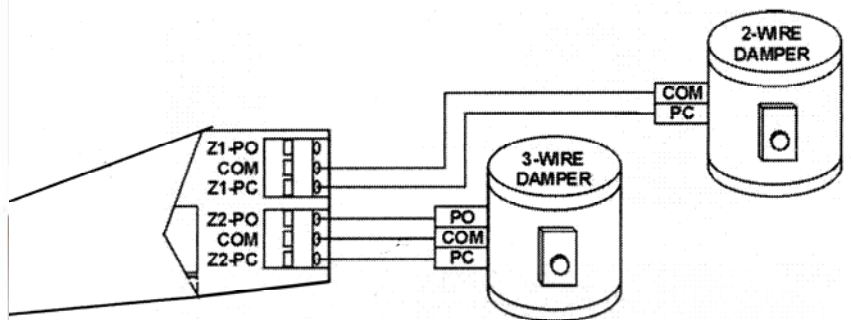
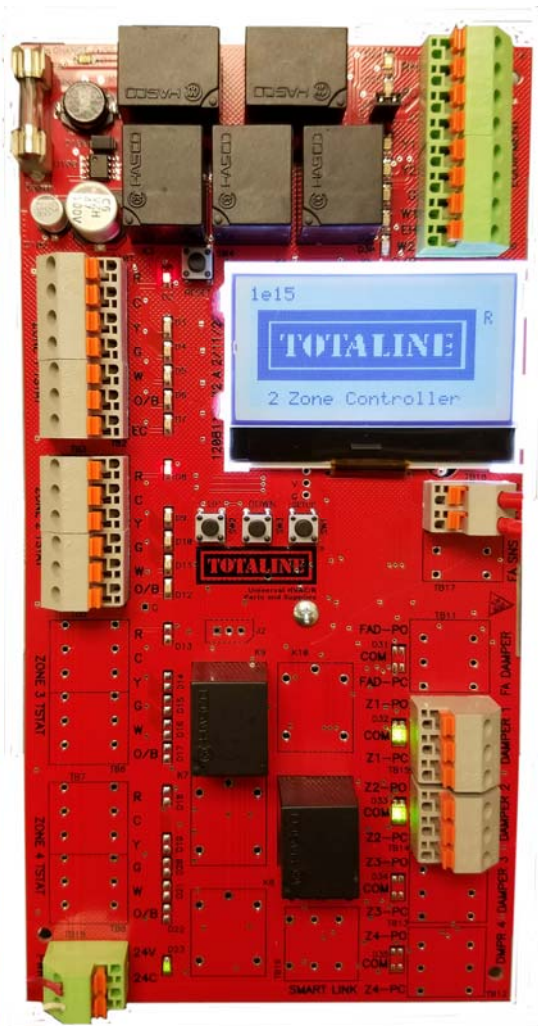

Wiring

Supply Air Temperature Sensor (SAS)

Sensor Placement (Location)

Gas/Electric - The SAS should be located in the Supply Air Plenum where it will sense AVERAGE air temperature within the Plenum. The ideal placement is 2 to 4 feet beyond the evaporator coil. Make sure the sensor is in the air stream and secured properly.

Heat Pump - The SAS should be located inside the air handler cabinet AFTER the evaporator coil but BEFORE the blower. Make sure the sensor is in the air stream and secured properly.

Sensor Wiring

Using the provided SAS, plug the two wires into the connector labeled SA SNS on the EasyZone control board.

NOTE: WITHOUT THE SENSOR, THE CONTROLLER WILL NOT OPERATE PROPERLY. ALL DAMPERS WILL REMAIN OPEN, AND THE CONTROLLER WILL ONLY ACCEPT EQUIPMENT CALLS FROM THE ZONE 1 THERMOSTAT.

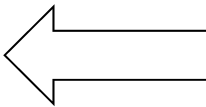
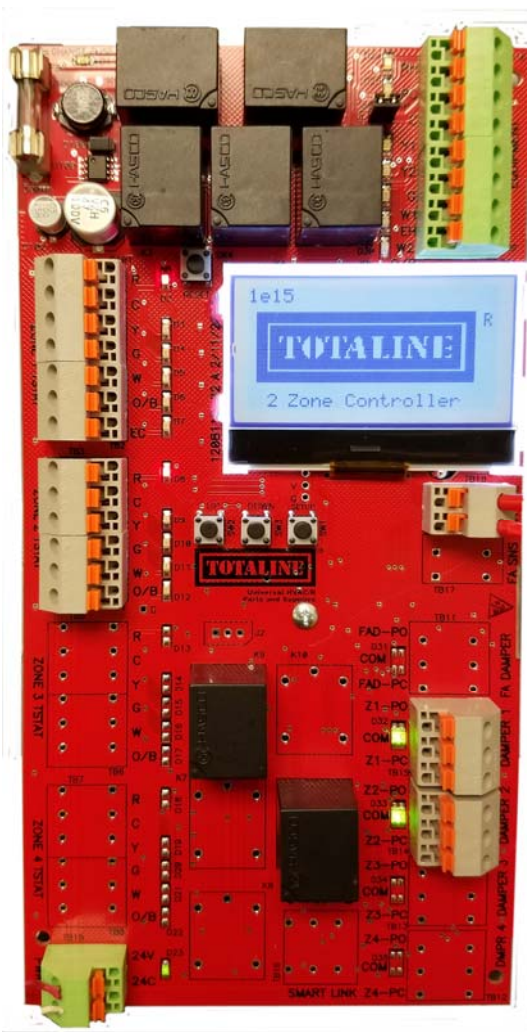

PLUG IN SUPPLY AIR SENSOR

THE ZONING SYSTEM WILL NOT OPERATE PROPERLY WITHOUT THE SUPPLY AIR SENSOR PLUGGED IN!



NOTE: IF THE SAS IS NOT PLUGGED INTO THE CONTROLLER, THE TEMPERATURE DISPLAY WILL SHOW TWO DASH LINES. THE CONTROLLER WILL ONLY ACCEPT CALLS FROM THE ZONE ONE THERMOSTAT. ALL DAMPERS WILL REMAIN OPEN.

Wiring

A/C - Gas Furnace and A/C - Electric Furnace

Using 18 gauge solid thermostat wire, connect the Equipment Control Wires from the Indoor Unit to the *EQUIPMENT* terminal block on the top right corner of the EasyZone Controller. Use the terminal labeled **W1/EH** for first stage heat. If using a two-stage furnace, connect **W2/OB** to **W2** on the indoor equipment. Connect **R** from the equipment to **RC** on the controller.

Connect **C** from the equipment to **C** on the EasyZone Controller. THE C TERMINAL FROM THE EQUIPMENT **MUST** BE CONNECTED TO THE CONTROLLER FROM THE EQUIPMENT FOR THE RC AND RH LED'S TO ILLUMINATE. POWER FROM THE EQUIPMENT TRANSFORMER WILL ILLUMINATE THE **RC** AND **RH** TERMINAL LED'S, INDICATING THE EQUIPMENT TRANSFORMER IS CONNECTED.

NOTE: IF USING A TWO-TRANSFORMER SYSTEM, WITH SEPARATE COOLING AND HEATING TRANSFORMERS, CONNECT THE **R** FROM THE COOLING TRANSFORMER TO **RC** ON THE CONTROLLER. CONNECT THE **R** FROM THE HEATING TRANSFORMER TO **RH** ON THE

CONTROLLERS. REMOVE THE BLACK JUMPER LOCATED JUST BELOW THE RC/RH LED'S TO SEPARATE THE

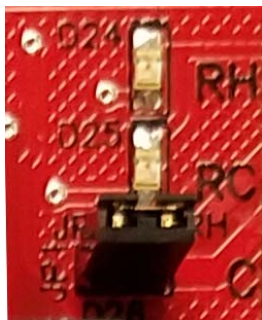

↑
JUMPER

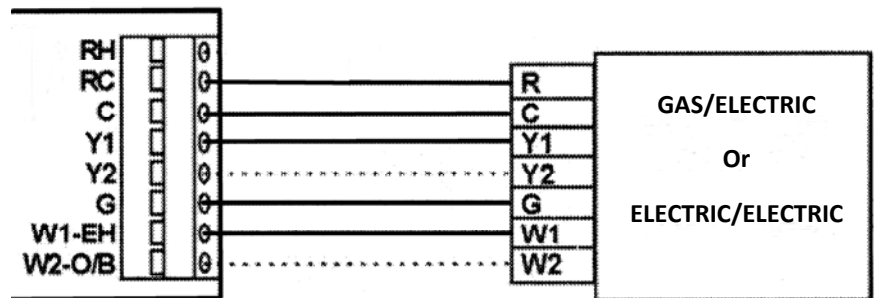

Electric Heat Pump

Using 18 gauge solid thermostat wire, connect the Equipment Control Wires from the Indoor Unit to the *EQUIPMENT* terminal Block on the top right corner of the EasyZone Controller. Use the terminal labeled **W1/EH** for the auxiliary heat strips.

Connect the **W2/OB** terminal to the **O/B** terminal on the equipment (REVERSING VALVE). Connect **R** from the equipment to **RC** on the EasyZone controller. Connect **C** from the equipment to **C** on the controller. THE C TERMINAL FROM THE EQUIPMENT **MUST** BE CONNECTED TO THE CONTROLLER FROM THE EQUIPMENT FOR THE RC AND RH LED'S TO ILLUMINATE. POWER FROM THE EQUIPMENT TRANSFORMER WILL ILLUMINATE THE **RC** AND **RH** TERMINAL LED'S, INDICATING THE EQUIPMENT TRANSFORMER IS CONNECTED AND WORKING.

NOTE: IF USING A TWO-TRANSFORMER SYSTEM, WITH SEPARATE COOLING AND HEATING TRANSFORMERS, CONNECT THE **R** FROM THE COOLING TRANSFORMER TO **RC** ON THE CONTROLLER. CONNECT THE **R** FROM THE HEATING TRANSFORMER TO **RH** ON THE CONTROLLERS. REMOVE THE BLACK JUMPER LOCATED JUST BELOW THE RC/RH LED'S TO SEPARATE THE POWER INPUTS.

Configuration and Setup

The TL-EZ2N controller has a state of the art microprocessor for reliable control of the equipment and zone dampers.

The simple step by step setup eliminates the need for confusing dip switches. The full status back-lit LCD display guides you thru each step of the setup process. Depending on the type of equipment selected, the display will show you each available option for the system type selected.

A/C - GAS HEAT AND A/C - ELECTRIC HEAT

Make sure that all wiring for the thermostats, zone dampers and equipment is complete. The **RH** and **RC** led's should be illuminated. The wire on the Supply Air Sensor (SAS) should be plugged firmly into the connector on the controller. Apply power from the 24VAC transformer connected to the **PWR** connector on the controller. The controller will power up and display a splash screen on the LCD display. The red **R** led's for both thermostats and the green **G** led's for both dampers will illuminate. The display will then show the factory default settings for the controller.

IF YOU GO PAST THE DESIRED SETUP OPTION, PRESS THE RESET BUTTON TO START OVER.

Press the **SETUP** button to enter the configuration mode. The screen will display the **SETUP MENU AND OPTION #03 - SET SYSTEM TYPE**. The default setting is **A/C - GAS HEAT**. Press the **UP** button to change the system type to **A/C - ELECTRIC HEAT**. Press the **SETUP** button to proceed to the next option.

OPTION #05 - SET OUTDOOR UNIT SPEED The default setting is **1-SPEED**. If using single stage equipment, press the **SETUP** button to proceed to the next option. If using 2-stage equipment, press the **UP** or **DOWN** button to select **2-SPEED**. Press the **SETUP** button to proceed to the next option.

OPTION #09 - SET GAS HI-TEMP CUT-OUT The default setting is **135° F (60° C)**. Press the **UP** or **DOWN** button to change the temperature. The adjustable range is **125° F to 150° F (57° to 65° C)**. Press the **SETUP** button to proceed to the next option.

NOTE: When using electric furnace, the HI-TEMP CUT-OUT should be set no higher than 125° F (52° C).

OPTION #10 - SET LO-TEMP CUTOUT The default setting is **48° F (8° C)**. Press the **UP** or **DOWN** button to change the temperature. The adjustable range is **42° F to 52° F (5° to 11° C)**. Press the **SETUP** button to proceed to the next option.

OPTION #21 - SET SECOND STAGE LOCK-OUT The default setting is **OFF**. Push the up or down button to turn on. (2-speed outdoor unit only) Press the **SETUP** button to proceed to the next option.

OPTION #22 - SET ZONE-1 PRIORITY The default setting is **OFF**. Press the **UP** or **DOWN** button to turn **ON**. When Zone-1 Priority is turned on, any call from Zone 1 will override the call from Zone 2. If Zone 1 has an active call, the controller will ignore an opposing call from Zone 2 until the call is dropped from Zone 1. If Zone 2 only has an active call, and an opposing call is received from Zone 1, the board will immediately go into **PURGE** for 3 minutes. It will then answer the call from Zone 1. Press the **SETUP** button to proceed to the next option.

OPTION #23 - SET AUTO CHANGEOVER TIME The default setting is **10 MINS**. Press the **UP** or **DOWN** button to change to **15 MINS**. This sets the amount of time that will elapse before switching modes when the controller is answering a call from one zone and the other zone makes an opposing call. At the end of the changeover time, the controller will go into a 3-minute **PURGE** and then answer the opposing call. **NOTE: THIS TIMER WILL ONLY OPERATE IF OPTION #22, ZONE-1 PRIORITY IS TURNED OFF**. Press the **SETUP** button to proceed to the next option.

OPTION #25 - ALLOW ZONE 1 TSTAT STAGING The default setting is off. Press the **UP** or **DOWN** button to turn this feature on. When this feature is enabled, the Zone 1 thermostat can initiate 2nd stage cooling (Y2) after a 1 minute minimum run time in first stage (Y1). Press the **SETUP** button to proceed to the next option.

OPTION #26 - SET 2ND STAGE COOLING STAGE BASED ON TIME ONLY The default setting is off. Press the **UP** or **DOWN** button to turn **ON**. Press the **SETUP** button to proceed to the next option.

Configuration and Setup

A/C - GAS HEAT AND A/C - ELECTRIC HEAT (Continued)

OPTION #27 - SET 2ND STAGE COOLING CUT-IN BASED ON TIME AND TEMP The default setting is **8 mins**. Push the **DOWN** button to change the timing to **6 mins** or **4 mins**. Press the **SETUP** button to proceed to the next option.

OPTION #28 - SET 2ND STAGE COOLING CUT-IN BASED ON TIME ONLY The default setting is **15 mins**. Push the **UP** button to change to **20 mins** or the **DOWN** button to change to **10 mins**. Press the **SETUP** button to exit the setup menu.

ELECTRIC HEAT PUMP AND AUXILIARY HEAT

Press the **SETUP** button to enter the configuration mode. The screen will display the **SETUP MENU AND OPTION #03 - SET SYSTEM TYPE**. The default setting is **A/C - GAS ELECTRIC**. Press the **UP** button twice to change the system to **ELECTRIC HEAT PUMP**. Press the **SETUP** button to proceed to the next option.

OPTION #05 - SET OUTDOOR UNIT SPEED The default setting is **1-SPEED**. If using single stage equipment, press the **SETUP** button to proceed to the next option. If using 2-stage equipment, press the **UP** or **DOWN** button to select **2-STAGE**. Press the **SETUP** button to proceed to the next option.

OPTION #06 - SET THERMOSTAT 1 TYPE The default setting is **GAS/ELECTRIC**. Press the **UP** or **DOWN** button to change to **HEAT PUMP**. Press the **SETUP** button to **SET THERMOSTAT 2 TYPE**. The default setting is **GAS/ELECTRIC**. Press the **UP** or **DOWN** button to change to **HEAT PUMP**. Press the **SETUP** button to proceed to the next option.

OPTION #07 - SET REVERSING VALVE ACTUATION The default setting is **REV-O**. Press the **UP** or **DOWN** button to change to **REV-B**. **NOTE:** When set as **REV-O**, the reversing valve will energize in **COOLING**. When set as **REV-B**, the reversing valve will energize in **HEATING**. Press the **SETUP** button to proceed to the next option

OPTION #10 - SET LO-TEMP CUTOUT The default setting is **48° F (8° C)**. Press the **UP** or **DOWN** button to change the temperature. The adjustable range is **42° F to 52° F (5° to 11° C)**. Press the **SETUP** button to proceed to the next option.

OPTION #11 - SET HEAT PUMP HI-TEMP CUTOUT The default setting is **120° F (48 C)**. Press the **UP** or **DOWN** button to change the setting. The adjustable range is **110° F - 125° F (43° to 52° C)**. Press the **SETUP** button to proceed to the next option.

OPTION #12 - SET AUX HEAT CUT-IN TEMP The default is **90° F (32° C)**. Press the **UP** or **DOWN** button to change the setting. The adjustable range is **90° - 100 F (32° - 37° C)**. Press the **SETUP** button to proceed to the next option.

OPTION #13 - SET AUX HEAT CUTIN TIME The default is **6 Mins**. Press the **UP** or **DOWN** button to change the setting. The adjustable range is **3 - 6 Mins**. Press the **SETUP** button to proceed to the next step.

OPTION #21 - SET SECOND STAGE LOCK-OUT The default setting is **OFF**. Push the up or down button to turn on. (2-speed outdoor unit only) Press the **SETUP** button to proceed to the next option.

OPTION #22 - SET ZONE-1 PRIORITY The default setting is **OFF**. Press the **UP** or **DOWN** button to turn **ON**. When Zone-1 Priority is turned on, any call from Zone 1 will override the call from Zone 2. If Zone 1 has an active call, the controller will ignore an opposing call from Zone 2 until the call is dropped from Zone 1. If Zone 2 only has an active call, and an opposing call is received from Zone 1, the board will immediately go into **PURGE** for 3 minutes. It will then answer the call from Zone 1. Press the **SETUP** button to proceed to the next option.

OPTION #23 - SET AUTO CHANGEOVER TIME The default setting is **10 MINS**.

Press the **UP** or **DOWN** button to change to **15 MINS**. This sets the amount of time that will elapse before switching modes when the controller is answering a call from one zone and the other zone makes an opposing call. At the end of the changeover time, the controller will go into a 3-minute **PURGE** and then answer the opposing call. **NOTE:** THIS TIMER WILL ONLY OPERATE IF OPTION #22, ZONE-1 PRIORITY IS TURNED **OFF**. Press the **SETUP** button to proceed to the next option.

Configuration and Setup

ELECTRIC HEAT PUMP (Continued)

OPTION #25 - ALLOW ZONE 1 TSTAT STAGING The default setting is off. Press the **UP** or **DOWN** button to turn this feature on. When this feature is enabled, the Zone 1 thermostat can initiate 2nd stage cooling (Y2) after a 1 minute minimum run time in first stage (Y1). Press the **SETUP** button to exit the configuration mode. The controller will display the System Idle screen.

OPTION #26 - SET 2ND STAGE COOLING STAGE BASED ON TIME ONLY The default setting is off. Press the **UP** or **DOWN** button to turn **ON**.

OPTION #27 - SET 2ND STAGE COOLING CUT-IN BASED ON TIME AND TEMP The default setting is **8 mins**. Push the **DOWN** button to change the timing to **6 mins** or **4 mins**. Press the **SETUP** button to proceed to the next option.

OPTION #28 - SET 2ND STAGE COOLING CUT-IN BASED ON TIME ONLY The default setting is **20 mins**. Push the **DOWN** button to change to **15 mins** or **10 mins**. Press the **SETUP** button to exit the setup menu.

SEQUENCE OF OPERATION

SINGLE STAGE COOLING (A/C AND HEAT PUMP)

On any cooling call from one of the thermostats, the controller will energize the **Y1** and **G** outputs to the equipment. The damper for the zone calling will remain open, and the damper for the zone NOT calling will close. During this call, if the other zone makes a cooling call, the zone damper will open. When a thermostat becomes satisfied, and if a call exists from the other thermostat, the damper on the satisfied zone will close. Once the other thermostat becomes satisfied, the controller will de-energize the **Y1** and **G** outputs to the equipment, and both dampers will open. (system idle)

LOW TEMP CUTOUT

During a cooling call, if the Supply Air Temperature falls BELOW the LOW TEMP CUTOUT temperature, the controller will de-energize the **Y1** output to the equipment and will leave the **G** output energized. A 3-minute DELAY TIMER will be displayed. After the 3-minute delay, if the Supply Air Temperature has risen ABOVE the LOW TEMP CUTOUT temperature, the controller will re-energize the **Y1** output to the equipment.

TWO STAGE COOLING (A/C AND HEAT PUMP)

The TL-EZ2N Controller utilizes built in intelligent SmartStaging. This allows the use of single stage thermostats on both zones. The controller will energize and de-energize second stage based on elapsed run time and the supply air temperature, or elapsed time only. If set up for time and temperature, on an initial call for cooling, the controller will energize the **Y1** and **G** outputs to the equipment. After an initial run time of 8 MINUTES, (adjustable to 6 mins or 4 mins) if the supply air temperature has not fallen to at least **10 DEGREES F (6 DEGREES C)** above the low temp cutout, the controller will energize **Y2** to the equipment. **Y2** will stay energized until the supply air temperature falls below **4 DEGREES F (1 DEGREE C)** above the low temp cutout. The controller will then turn off **Y2**. This cycle will continue as the supply air temperature rises and falls. If set up for time only, the controller will energize **Y2** after an initial run time of **20 mins, 15 mins or 10 mins**.

(TWO STAGE COOLING CONTINUED)

STAGING CHART

NOTE: EXAMPLE BASED ON FACTORY DEFAULT SETTINGS

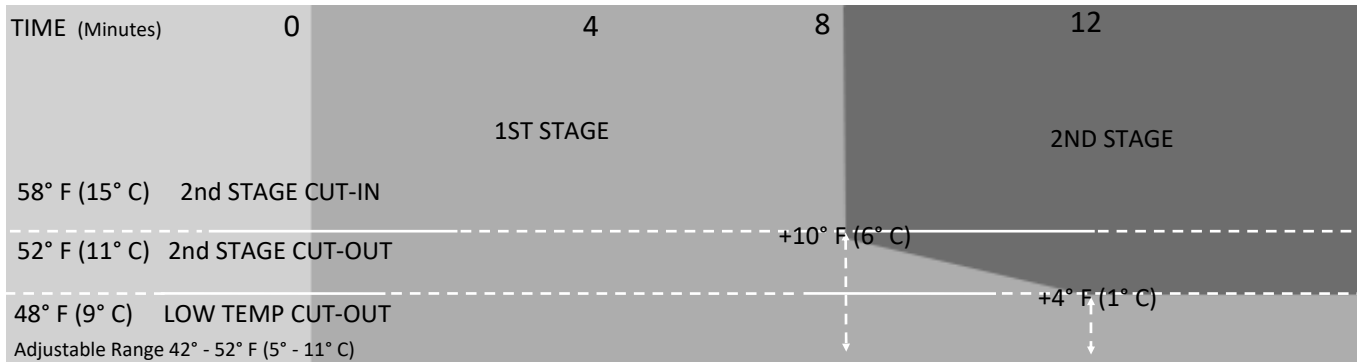

SINGLE STAGE HEATING (GAS & ELECTRIC HEAT / NOT HEATPUMP)

On any heating call from one of the thermostats, the controller will energize the **W1** output to the equipment. After 60 SECONDS of initial run time, the controller will energize the **G** output to the equipment. If the supply air temperature rises above the HI TEMP CUTOOUT setting, the controller will de-energize the **W1** output to the equipment. After a 3-minute time delay, if a call still exists and the supply air temperature has fallen below the HI TEMP CUTOOUT, the controller will re-energize the **W1** output to the equipment.

TWO STAGE HEATING (GAS & ELECTRIC HEAT / NOT HEATPUMP)

On any heating call from one of the thermostats, the controller will energize the **W1** output to the equipment. After 60 SECONDS of initial run time, the controller will energize the **G** output to the equipment. After 8 MINUTES of initial run time, if the supply air temperature has not risen to at least 25 DEGREES (F°) BELOW the HI TEMP CUTOOUT, the controller will energize **W2** to the equipment. The system will run in second stage heating until the supply air temperature rises to 10 DEGREES (F°) below the HI TEMP CUTOOUT. The controller will then de-energize **W2**. If the supply air temperature falls to 25 DEGREES (F°) below the HI TEMP CUTOOUT, the controller will re-energize **W2**. This staging will continue until the thermostat is satisfied and the controller turns off the equipment.

NOTE: EXAMPLE BASED ON FACTORY DEFAULT SETTINGS

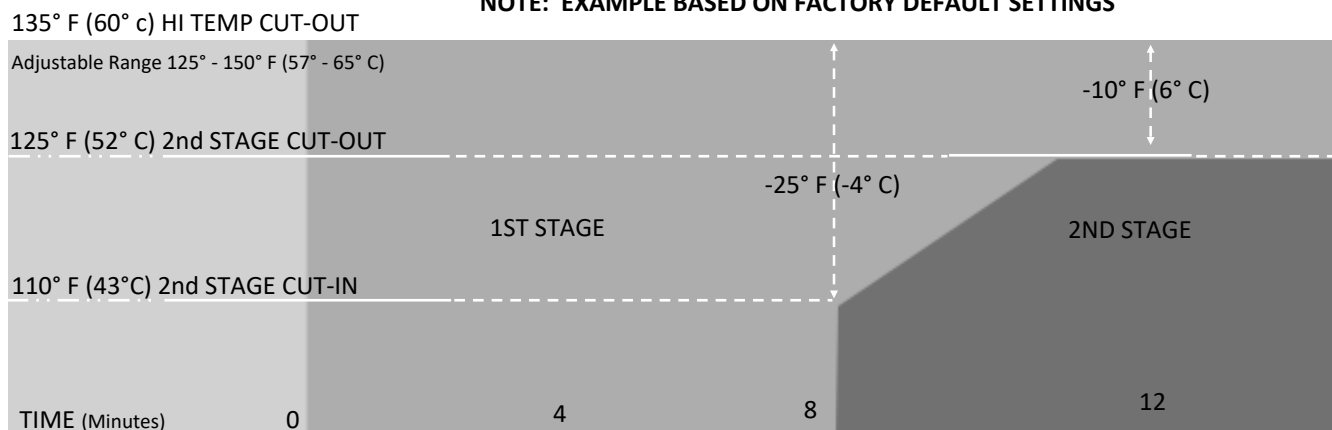

SINGLE STAGE HEATING - HEATPUMP

On any heating call from one of the thermostats (**Y** is using heatpump thermostats, **W** if using gas/electric thermostats) the controller will energize the **Y1** and **G** outputs to the equipment. A 3-minute minimum run timer will be displayed. After **6 MINUTES** of initial run time (Factory default. Adjustable 3-6 minutes) if the supply air temperature has not reached **90° F (32° C)**(Factory default. Adjustable **90-100° F (32-37° C)**) the controller will energize the **W1** output to the equipment (Auxiliary Heat). The equipment will continue to run in **AUXILIARY HEAT** until the supply air temperature rises to **10° F (6° C)** above the **AUXILIARY HEAT CUT-IN TEMPERATURE**. (Adjusts with Aux. Heat Cut-In Setting). The controller will continue to stage auxiliary heat on and off based on supply air temperature. If the supply air temperature rises above the **HI TEMP CUT-OUT** temperature, the controller will de-energize the **Y1** output to the equipment and leave the **G** output energized. A 3-minute compressor delay timer will be displayed. After 3 minutes, if the supply air temperature has fallen below the **HI TEMP CUT-OUT** temperature, the controller will re-energize the **Y1** output to the equipment. See staging chart below.

TWO STAGE HEATING - HEATPUMP

On any heating call from one of the thermostats (**Y** if using heatpump thermostats, **W** if using gas/electric thermostats) the controller will energize the **Y1** and **G** outputs to the equipment. After 4 minutes of initial run time, if the supply air temperature has not reached **105° F (41° C)** (15° F (9° C) below the **HIGH TEMP CUTOUT**), the controller will energize **Y2** to the equipment. **Y2** will remain energized until the supply air temperature reaches **115° F (46° C)** (5° F (1° C) below the **HIGH TEMP CUTOUT**). The controller will then de-energize **Y2**. The controller will continue to stage **Y2** on and off based on the supply air temperature. After 6 MINUTES of initial run time, if the supply air has not reached at least **90°F (32° C)**, the controller will energize **W1** to turn on auxiliary heat. **W1** will remain energized until the supply air temperature reaches **100° F (38° C)** (20° F below the **HIGH TEMP CUTOUT**). See staging chart below. **NOTE: AUX HEAT TIME AND TEMPERATURE STAGING IS NOT MANUALLY ADJUSTABLE ON TWO-SPEED HEAT PUMP EQUIPMENT. THE SECOND STAGE AND AUX HEAT STAGING TEMPERATURES MOVE UP AND DOWN BASED ON THE HIGH TEMP CUTOUT SETTING.**

ELECTRIC HEAT PUMP WITH ELECTRIC AUXILIARY HEAT

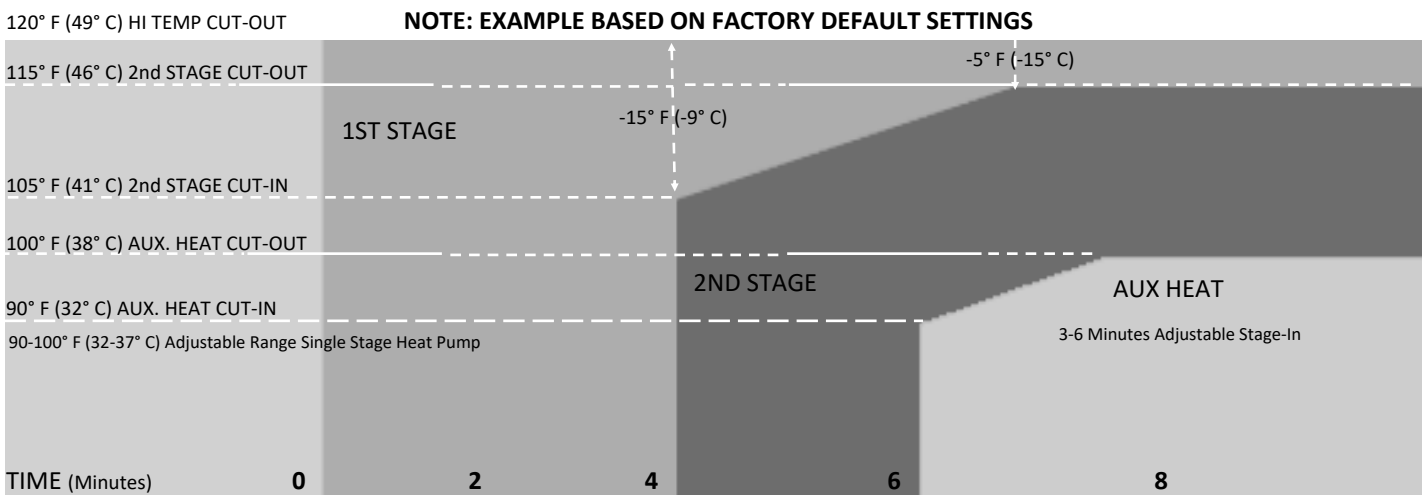

EMERGENCY HEAT

Emergency heat can **ONLY** be initiated by a HEAT PUMP THERMOSTAT connected to the ZONE 1 thermostat input. A HEAT PUMP THERMOSTAT SHOULD **ALWAYS** be used for the ZONE 1 thermostat. If the ZONE 1 thermostat calls for EMERGENCY HEAT, the Totaline controller will be **LOCKED** into emergency heat. **ANY** call for heat from either zone will turn on auxiliary heat. The controller can be **UNLOCKED** by making a call for compressor (heat or cool) from the Zone 1 thermostat.

AUTO CHANGEOVER

It is possible to have one zone calling for cooling and the other zone calling for heating (opposing calls). When an opposing call occurs, a CHANGEOVER TIMER (10 or 15 minutes - Adjustable) will display on the screen. After the timer has reached zero, the system will go into PURGE MODE for **3-MINUTES**. (See PURGE mode below). At the end of the 3-minute purge, the system will switch over to the other mode. If an opposing call still exists, the CHANGEOVER TIMER will

PURGE

Purge occurs whenever the system is running with only one zone calling, and the other zone makes an opposing call. After the changeover time has elapsed the controller turns off the equipment and leaves the fan (**G**) energized. The last zone calling will remain open during the **3 MINUTE** purge (countdown timer displayed on screen). This allows the temperature in the ductwork to equalize before starting the opposing call.

TIME DELAY

The TL-EZ2N controller features a TIME DELAY MODE that is designed to protect the compressor from short cycling. The time delay is initiated each time the compressor is de-energized. A 3-MINUTE DELAY timer will be displayed on the screen during this time. The compressor **CANNOT** be restarted until the timer has counted down to zero.

RH/RC JUMPER

The RH/RC Jumper is factory installed on the SmartZone Controller. If the equipment requires separate transformers for heating and cooling, REMOVE the jumper [JP1] located next to the "C" equipment connector. **NOTE: The jumper should NOT be removed for heat pump systems.**

ECONOMY MODE

The ECONOMY MODE (**EC**) input on the ZONE 1 TSTAT connector allows the use of a switch, occupancy sensor or dry contact to prevent ZONE 2 from making equipment calls. ZONE 2 will only be able to open and close the damper. Only ZONE 1 will be able to make equipment calls.

EQUIPMENT TEST MODE

The TL-EZ2N Controller can be put into an EQUIPMENT TEST MODE by powering the controller. After the IDLE screen appears, hold down the RESET BUTTON, then hold down the SETUP BUTTON, release the RESET BUTTON and then release the SETUP BUTTON. The controller will now only accept calls from the ZONE 1 thermostat, and will not operate the dampers. This allows the installer to set the bypass damper, check the refrigerant charge on the system and verify proper airflow thru the system. After all testing is complete, press and release the RESET button. The controller will reset and go into IDLE mode awaiting calls.

TROUBLESHOOTING CALL TECH SUPPORT **BEFORE** REPLACING TOTALINE CONTROLLER.

SYMPTON	POSSIBLE CAUSE
DISPLAY IS BLANK	<ul style="list-style-type: none"> > VERIFY OUTPUT OF TRANSFORMER, INCLUDING CONNECTIONS TO PRIMARY, SECONDARY AND ZONE PANEL CONNECTOR > CHECK TRANSFORMER FUSE > CHECK FOR SHORT IN WIRING CONNECTED TO ZONE PANEL (REMOVE THERMOSTAT AND DAMPER WIRES) > REPLACE ZONE PANEL FUSE IF RED LED AT FUSE HOLDER IS ILLUMINATED
DISPLAY READS --	<ul style="list-style-type: none"> > SUPPLY AIR TEMPERATURE SENSOR IS NOT CONNECTED TO PANEL > SUPPLY AIR TEMPERATURE SENSOR HAS A LOOSE CONNECTION > SUPPLY AIR TEMPERATURE SENSOR IS DEFECTIVE <p>NOTE: ZONE PANEL WILL ONLY ACCEPT CALLS FROM THE ZONE 1 THERMOSTAT AND WILL NOT CONTROL DAMPERS WHEN NO SUPPLY AIR SENSOR IS DETECTED</p>
THERMOSTAT INDICATES CALL BUT EQUIPMENT TERMINALS NOT RESPONDING	<ul style="list-style-type: none"> > SMARTZONE IS IN "DELAY" OR "PURGE" - DISPLAY WILL SHOW TIMER COUNTING DOWN FROM 3 MINUTES > AN INCOMPATIBLE THERMOSTAT IS CONNECTED - THERMOSTATS WITH A "COMMON" TERMINAL SHOULD BE USED > WIRING FROM ZONE PANEL TO EQUIPMENT COULD BE LOOSE OR DAMAGED > TRANSFORMER POWERING ZONE PANEL COULD HAVE INSUFFICIENT VA RATING > PRIMARY CIRCUIT POWERIING ZONE PANEL TRANSFORMER COULD BE BEYOND CAPACITY - USE DEDICATED CIRCUIT FROM BREAKER PANEL
EQUIPMENT OUTPUTS INDICATES CALL FOR HEAT/COOL BUT EQUIPMENT NOT ENERGIZING	<ul style="list-style-type: none"> > RC/RH JUMPER MISSING OR INSTALLED ON ONLY ONE PIN > EQUIPMENT TRANSFORMER NOT CONNECTED OR LOOSE CONNECTION - CHECK FOR 24 VOLT INPUT FROM EQUIPMENT > ECO MODE ENERGIZED: "EC" WILL BE DISPLAYED ON SCREEN AND "EC" LED ILLUMINATED ON ZONE 1 THERMOSTAT > ZONE PANEL HAS DEFECTIVE RELAY - CALL TECH SUPPORT FOR RMA VERIFICATION